

ANALOG COMINATION METER

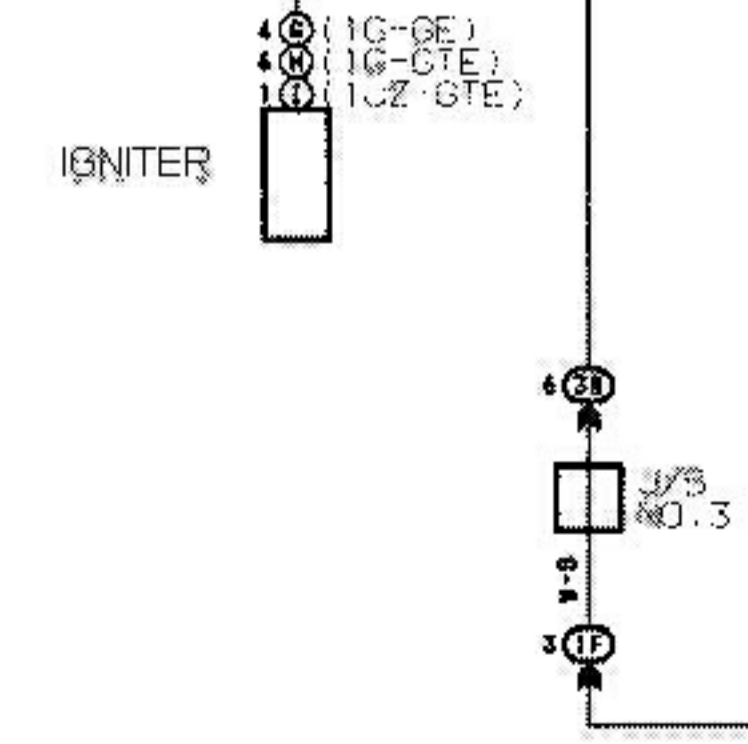

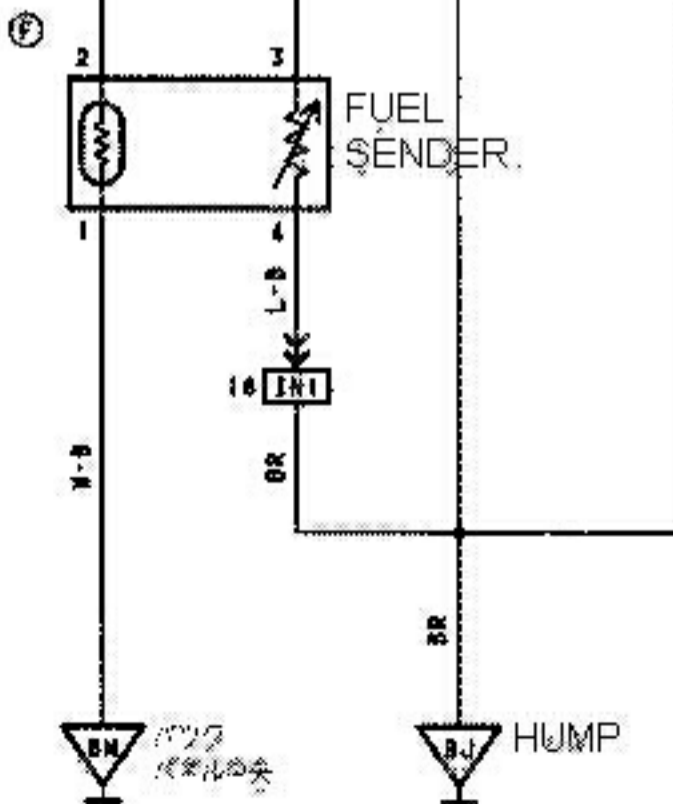

ANALOG COMBINATION METER

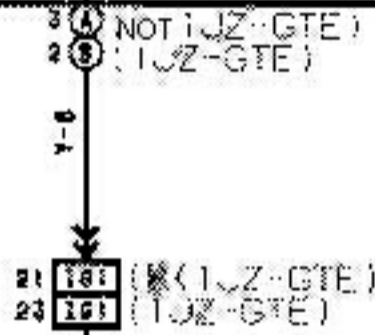
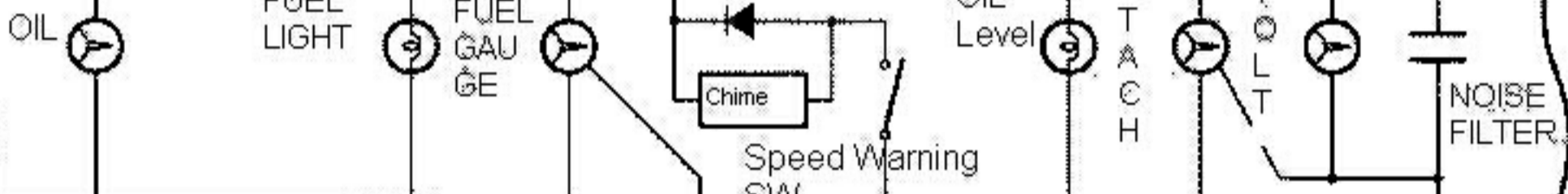
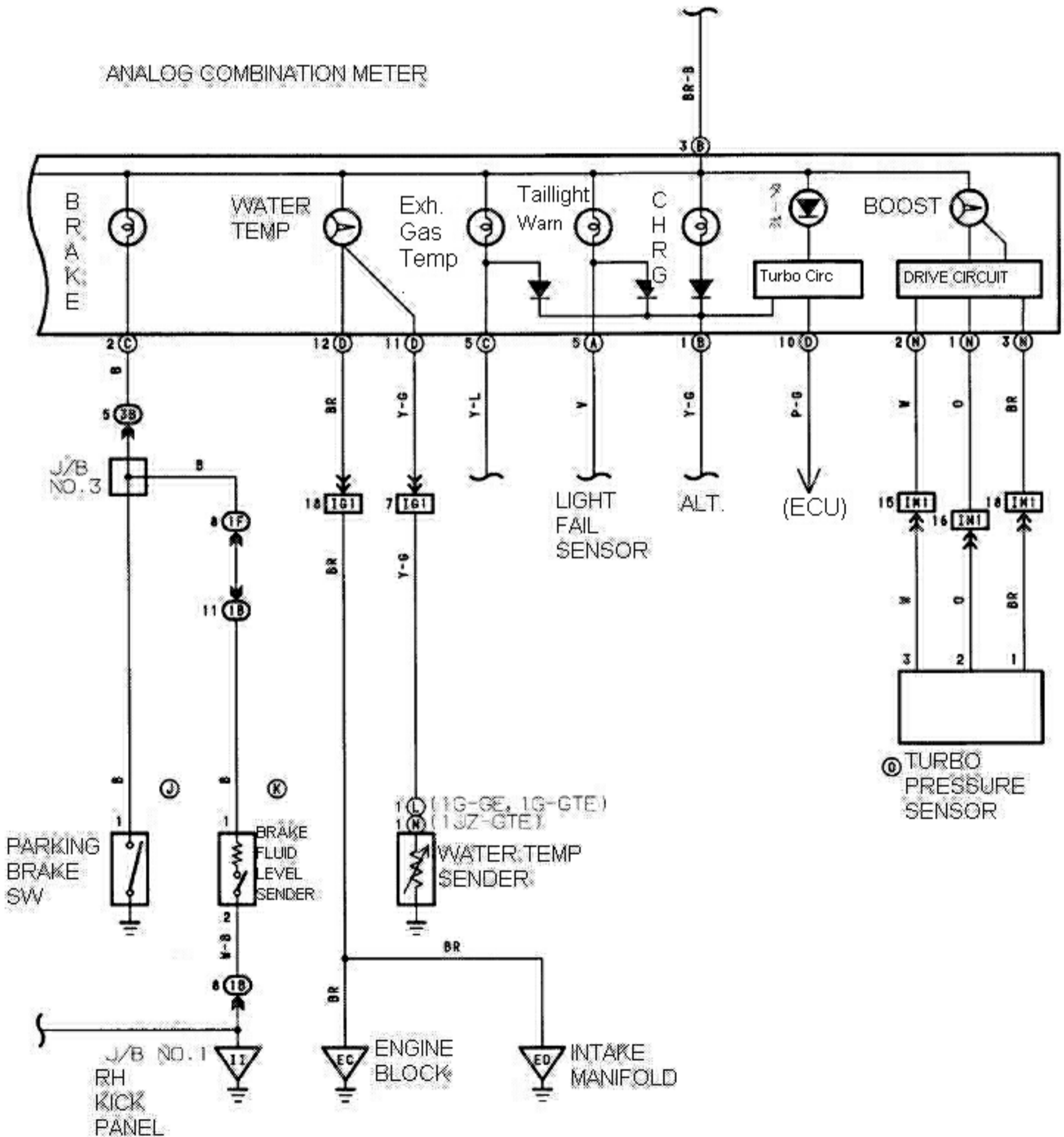



Ⓐ 青色

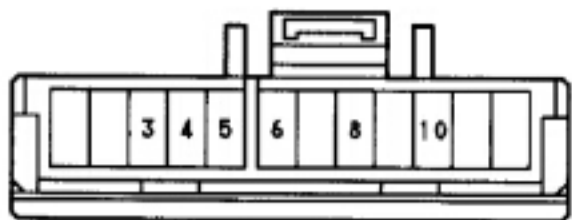

Ⓑ 茶色



Ⓒ 灰色

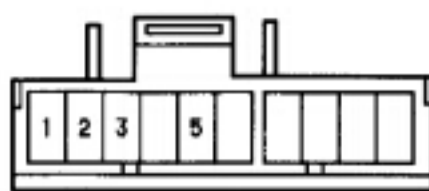

Ⓓ

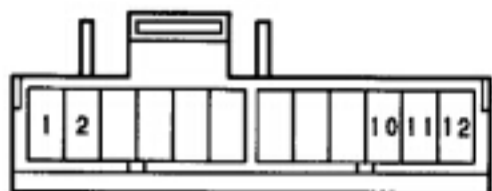

Ⓔ 黒色



Ⓕ



Ⓖ 黒色



Ⓖ 濃灰色

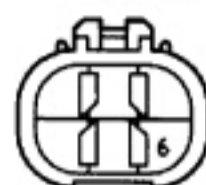

Ⓘ 黒色



Ⓙ



Ⓚ 灰色



Ⓛ 灰色



Ⓜ 灰色



Ⓝ



Ⓞ 灰色



Ⓟ

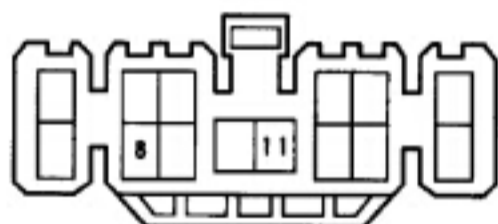

Ⓠ



Ⓡ 青色

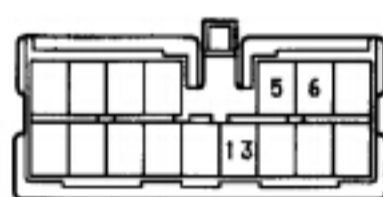

IG1 濃灰色

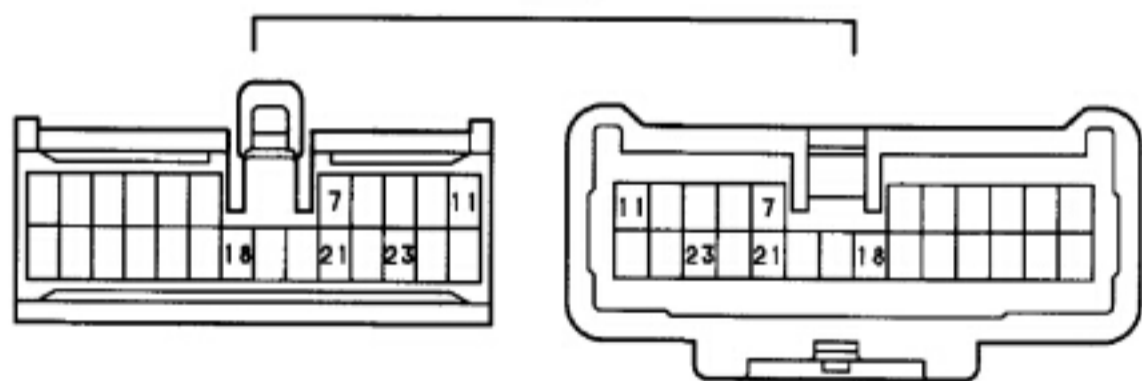

IMI

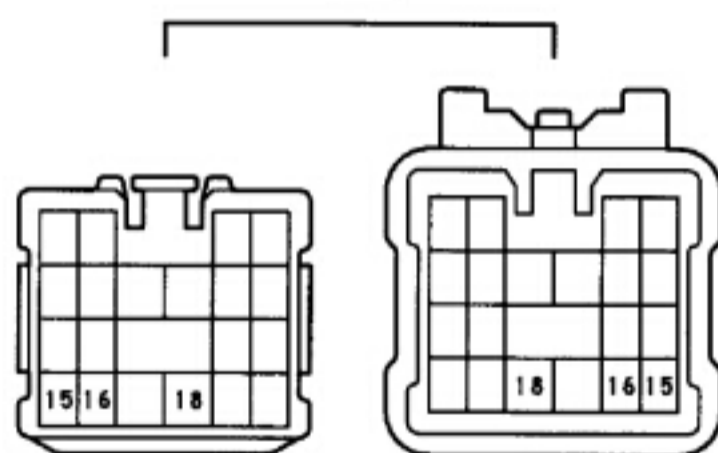

INI 濃灰色

